

## Titanium Series - Model: 203337L

### Radius Corner

Rear positioned drain holes to maximize usable bowl and cabinet storage space below

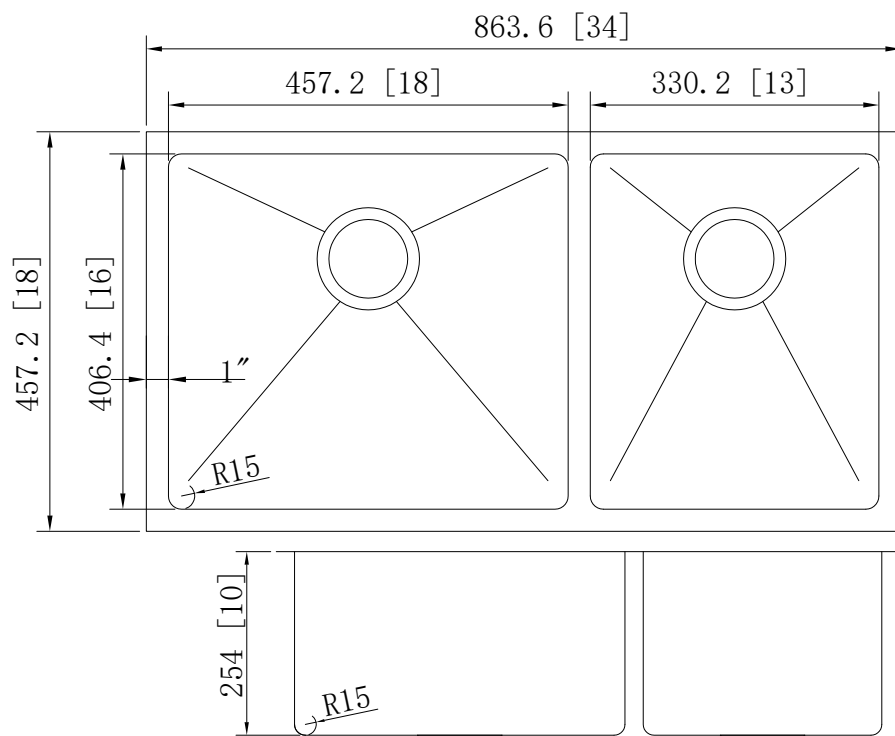

### Specifications:

- Handcrafted
- 304 Stainless Steel 16 Gauge
- 18/10 Chrome Nickel Content
- Bowl Corner Radius of 15 mm
- Brushed Finish
- Clips & Template
- Stainless Steel Strainer
- 10" Deep

Outside: 34" x 18" x 10"  
Inside: 32" x 16" x 10"  
Bowl Size: 18" x 16" x 10"  
13" x 16" x 10"

Minimum Cabinet Size 36"

### Certification/Warranty

- ASME A 112.19.3
- CSA B45.4
- Limited Lifetime Warranty

### Optional Accessories



Model: 202012  
Strainer

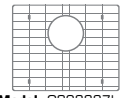

Model: G203337L B  
Model: G203337L S  
Grids



Model: 202041  
Plate Holder



Model: 202040  
Colander



Roll Up Dish Drying Rack  
Model: 202043



Cutting Board  
Model: 202020

*Bosco Canada Inc. is known around the world for producing high quality kitchen sinks that incorporate modern design and functional superiority in every piece they manufacture.*