

## Deluxe Series - Model: 202230 Plus

### Radius Corner

Rear positioned drain holes to maximize usable bowl and cabinet storage space below

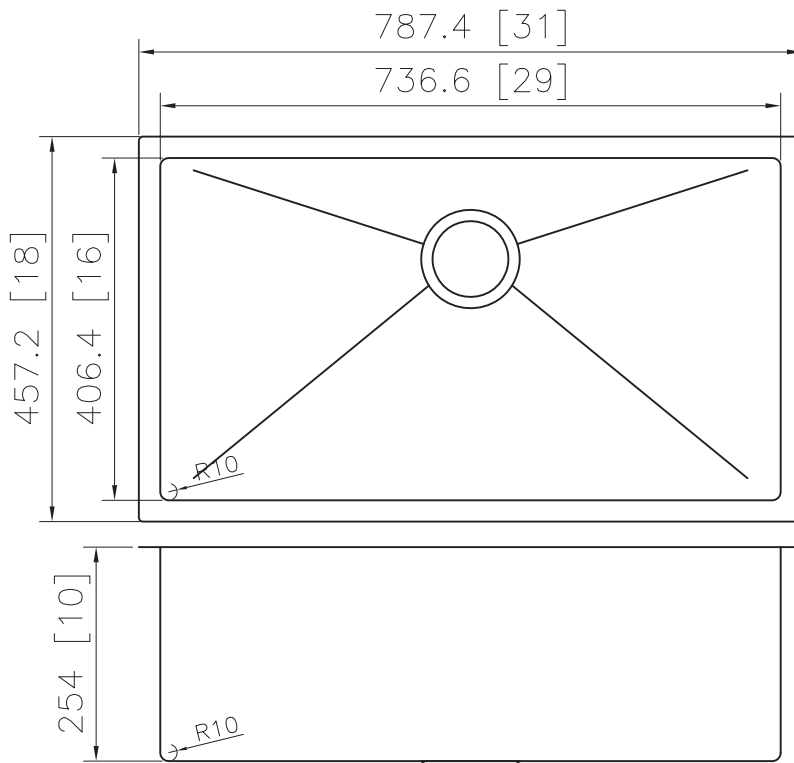

### Specifications:

- Handcrafted
- 316 Stainless Steel 16 Gauge
- 18/10 Chrome Nickel Content
- Bowl Corner Radius of 10 mm
- Undermount Clips
- Template
- Stainless Steel Strainer
- 10" Deep

Outside: 31" x 18" x 10"  
Inside: 29" x 16" x 10"

Minimum cabinet size 33"

### Certification/Warranty

- ASME A 112.19.3
- CSA B45.4
- Limited Lifetime Warranty

### Included Accessories

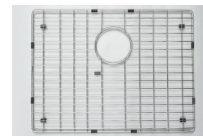

**Model: G202230**  
Grid



**Model: 202041**  
Plate Holder

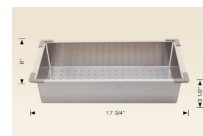

**Model: 202040**  
Colander



**Model: 202012**  
Strainer

### Optional Accessories



**Model: 202015**  
Utensil Rack



**Model: 202020**  
Cutting Board

*Bosco Canada Inc. is known around the world for producing high quality kitchen sinks that incorporate modern design and functional superiority in every piece they manufacture.*